

# LM4875 Boomer® Audio Power Amplifier Series

## 750 mW Audio Power Amplifier with DC Volume Control and Headphone Switch

### General Description

The LM4875 is a mono bridged audio power amplifier with DC voltage volume control. The LM4875 is capable of delivering 750mW of continuous average power into an 8Ω load with less than 1% THD when powered by a 5V power supply. Switching between bridged speaker mode and headphone (single ended) mode is accomplished using the headphone sense pin. To conserve power in portable applications, the LM4875's micropower shutdown mode ( $I_Q = 0.7\mu A$ , typ) is activated when less than 300mV is applied to the DC Vol/SD pin.

Boomer audio power amplifiers are designed specifically to provide high power audio output while maintaining high fidelity. They require few external components and operate on low supply voltages.

### Applications

- GSM phones and accessories, DECT, office phones
- Hand held radio
- Other portable audio devices

### Key Specifications

■ $P_O$ at 1.0% THD+N into 8Ω	750mW (typ)
■ $P_O$ at 10% THD+N into 8Ω	1W (typ)
■ Shutdown current	0.7μA(typ)
■ Supply voltage range	2.7V to 5.5V

### Features

- Precision DC voltage volume control
- Headphone amplifier mode
- "Click and pop" suppression
- Shutdown control when volume control pin is low
- Thermal shutdown protection

### Typical Application

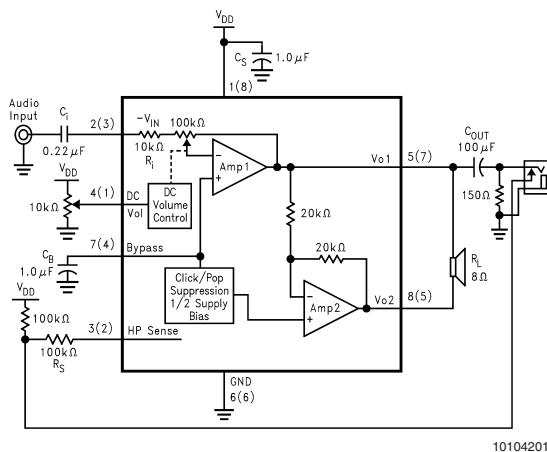
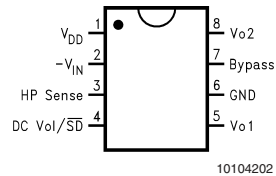

FIGURE 1. Typical Audio Amplifier Application Circuit

### Connection Diagram

Small Outline Package (SO)  
Mini Small Outline Package (MSOP)



Top View

Order Number LM4875M, LM4875MM  
See NS Package Number M08A, MUA08A

BOOMER™ is a trademark of National Semiconductor Corporation.

**Absolute Maximum Ratings** (Note 2)

If Military/Aerospace specified devices are required, please contact the National Semiconductor Sales Office/Distributors for availability and specifications.

Supply Voltage	6.0V
Storage Temperature	-65°C to +150°C
Input Voltage	-0.3V to $V_{DD}$ +0.3V
Power Dissipation (Note 3)	Internally Limited
ESD Susceptibility (Note 4)	2000V
ESD Susceptibility (Note 5)	200V
Junction Temperature	150°C
Soldering Information	
Vapor Phase (60 sec.)	215°C
Infrared (15 sec.)	220°C

## Thermal Resistance

$\theta_{JC}$ (SOP)	35°C/W
$\theta_{JA}$ (SOP)	150°C/W
$\theta_{JC}$ (MSOP)	56°C/W
$\theta_{JA}$ (MSOP)	190°C/W

**Operating Ratings**

## Temperature Range

$$T_{MIN} \leq T_A \leq T_{MAX} \quad -40^\circ\text{C} \leq T_A \leq +85^\circ\text{C}$$

## Supply Voltage

$$2.7\text{V} \leq V_{DD} \leq 5.5\text{V}$$

See AN-450 "Surface Mounting and their Effects on Product Reliability" for other methods of soldering surface mount devices.

**Electrical Characteristics** (Notes 1, 2)

The following specifications apply for  $V_{DD} = 5\text{V}$ , unless otherwise specified. Limits apply for  $T_A = 25^\circ\text{C}$ .

Symbol	Parameter	Conditions	LM4875			
			Min (Note 7)	Typical (Note 6)	Max (Note 7)	Units
$V_{DD}$	Supply Voltage		2.7		5.5	V
$I_{DD}$	Quiescent Power Supply Current	$V_{IN} = 0\text{V}$ , $I_O = 0\text{A}$ , HP Sense = 0V		4	7	mA
		$V_{IN} = 0\text{V}$ , $I_O = 0\text{A}$ , HP Sense = 5V		3.5	6	mA
$I_{SD}$	Shutdown Current	$V_{PIN4} \leq 0.3\text{V}$		0.7		$\mu\text{A}$
$V_{OS}$	Output Offset Voltage	$V_{IN} = 0\text{V}$		5	50	mV
$P_O$	Output Power	THD = 1% (max), HP Sense < 0.8V, $f = 1\text{kHz}$ , $R_L = 8\Omega$	500	750		mW
		THD = 10% (max), HP Sense < 0.8V, $f = 1\text{kHz}$ , $R_L = 8\Omega$		1.0		W
		THD + N = 1%, HP Sense > 4V, $f = 1\text{kHz}$ , $R_L = 32\Omega$		80		mW
		THD = 10%, HP Sense > 4V, $f = 1\text{kHz}$ , $R_L = 32\Omega$		110		mW
THD+N	Total Harmonic Distortion + Noise	$P_O = 300\text{mWrms}$ , $f = 20\text{Hz}-20\text{kHz}$ , $R_L = 8\Omega$		0.6		%
PSRR	Power Supply Rejection Ratio	$V_{RIPPLE} = 200\text{mVrms}$ , $R_L = 8\Omega$ , $C_B = 1.0\mu\text{F}$ , $f = 1\text{kHz}$		50		dB
Gain <sub>RANGE</sub>	Single-Ended Gain Range	Gain with $V_{PIN4} \geq 4.0\text{V}$ , (80% of $V_{DD}$ )	18.8	20		dB
		Gain with $V_{PIN4} \leq 0.9\text{V}$ , (20% of $V_{DD}$ )	-70	-72		dB
$V_{IH}$	HP Sense High Input Voltage		4			V
$V_{IL}$	HP Sense Low Input Voltage				0.8	V

**Note 1:** All voltages are measured with respect to the ground pin, unless otherwise specified.

**Note 2:** "Absolute Maximum Ratings" indicate limits beyond which damage to the device may occur. "Operating Ratings" indicate conditions for which the device is functional, but do not guarantee specific performance limits. "Electrical Characteristics" state DC and AC electrical specifications under particular test conditions that guarantee specific performance limits. This assumes that the device operates within the Operating Ratings. Specifications are not guaranteed for parameters where no limit is given. The typical value, however, is a good indication of device performance.

**Note 3:** The maximum power dissipation must be derated at elevated temperatures and is dictated by  $T_{JMAX}$ ,  $\theta_{JA}$ , and the ambient temperature  $T_A$ . The maximum allowable power dissipation is  $P_{DMAX} = (T_{JMAX} - T_A)/\theta_{JA}$  or the number given in the Absolute Maximum Ratings, whichever is lower. For the LM4875M,  $T_{JMAX} = 150^\circ\text{C}$ .

**Note 4:** Human body model, 100pF discharged through a 1.5k $\Omega$  resistor.

**Note 5:** Machine Model, 220pF-240pF discharged through all pins.

**Note 6:** Typicals are measured at 25°C and represent the parametric norm.

**Note 7:** Limits are guaranteed to National's AOQL (Average Outgoing Quality Level).

**Note 8:** The quiescent power supply current depends on the offset voltage when a practical load is connected to the amplifier.

# External Components Description

(Figure 1)

Components	Functional Description
1. $C_i$	Input coupling capacitor blocks DC voltage at the amplifier's input terminals. It also creates a highpass filter with the internal $R_i$ that produces an $f_c = 1/(2\pi R_i C_i)$ ( $10k\Omega \leq R_i \leq 100k\Omega$ ). Refer to the Application Information section, <b>Selecting External Components</b> , for an explanation of determining the value of $C_i$ .
2. $C_S$	The supply bypass capacitor. Refer to the <b>Power Supply Bypassing</b> section for information about properly placing, and selecting the value of, this capacitor.
3. $C_B$	The capacitor, $C_B$ , filters the half-supply voltage present on the BYPASS pin. Refer to the Application Information section, <b>Selecting External Components</b> , for information concerning proper placement and selecting $C_B$ 's value.

## Typical Performance Characteristics

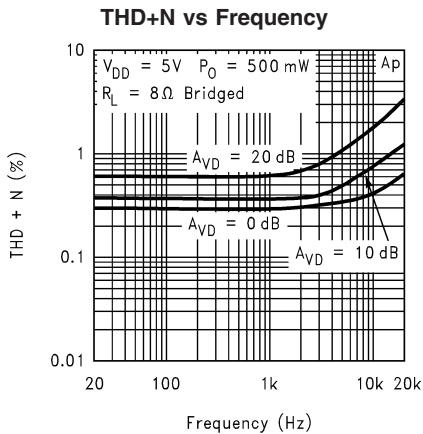

10104205

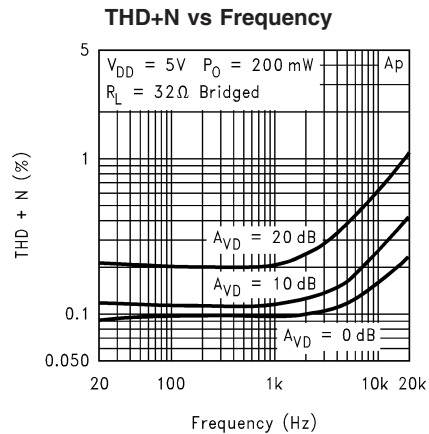

10104206

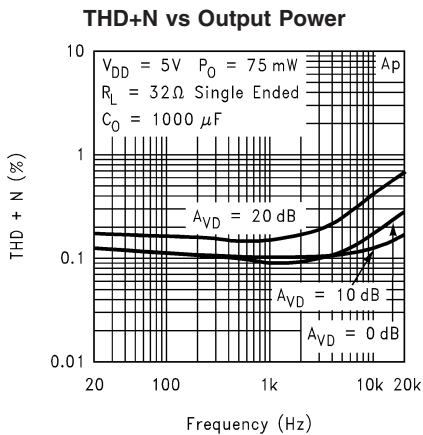

10104207

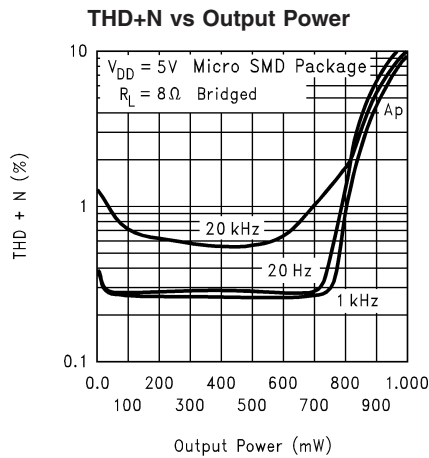

10104208

# Typical Performance Characteristics (Continued)

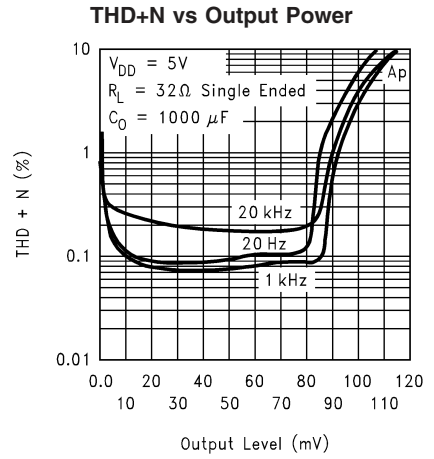
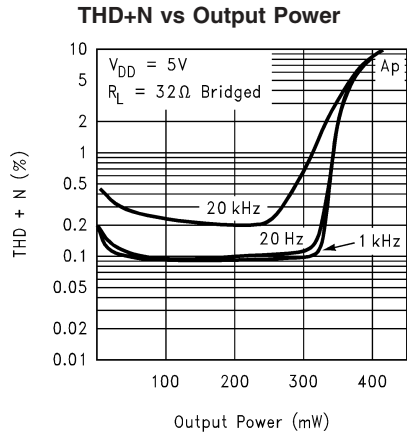

### Power Dissipation vs Load Resistance

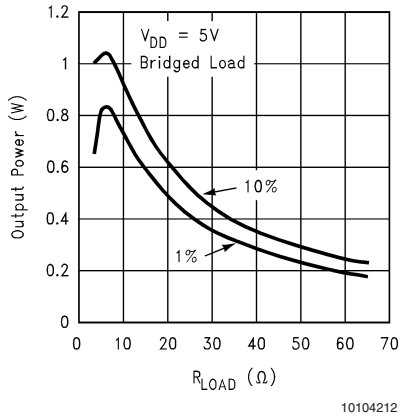

### Power Dissipation vs Output Power

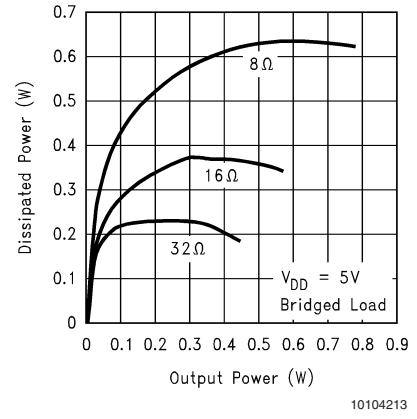

### Power Derating Curve

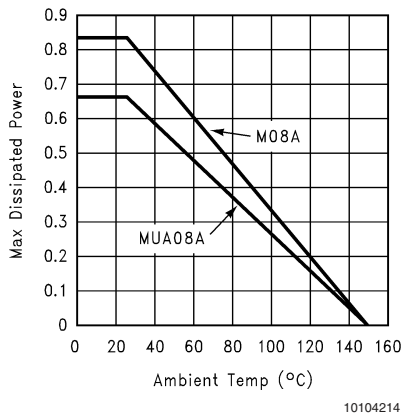

### Clipping Voltage vs RL

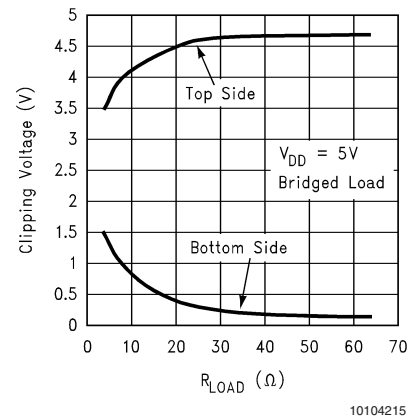

Typical Performance Characteristics (Continued)

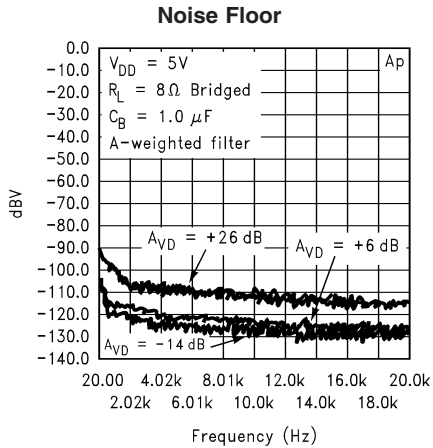

10104216

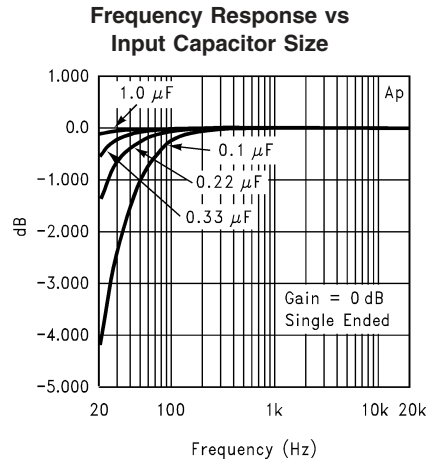

10104217

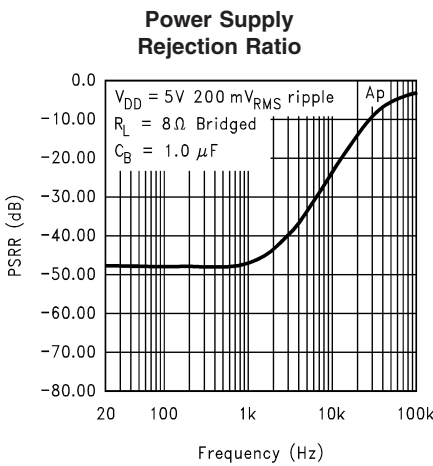

10104218

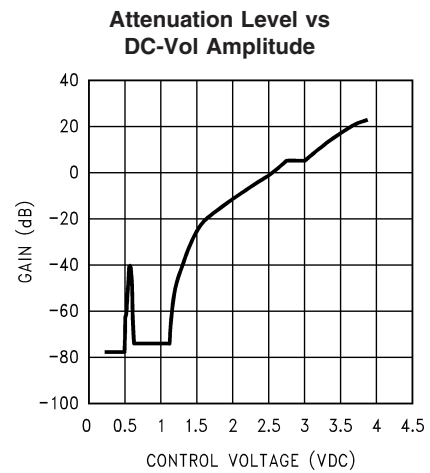

10104219

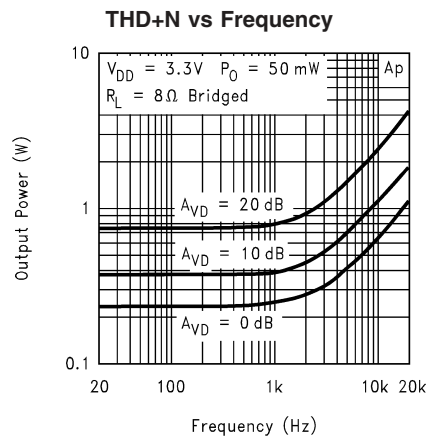

10104220

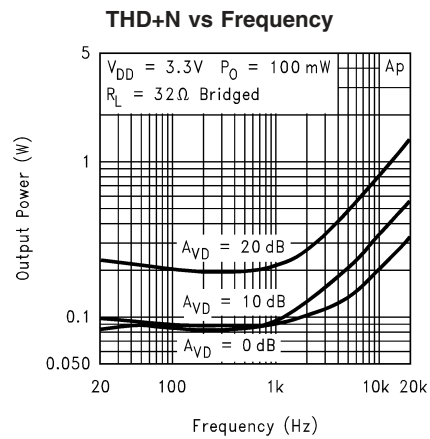

10104221

# Typical Performance Characteristics (Continued)

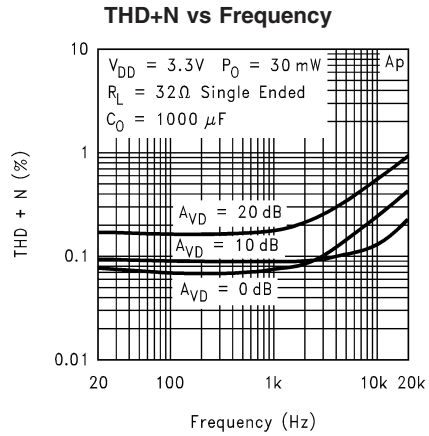

10104222

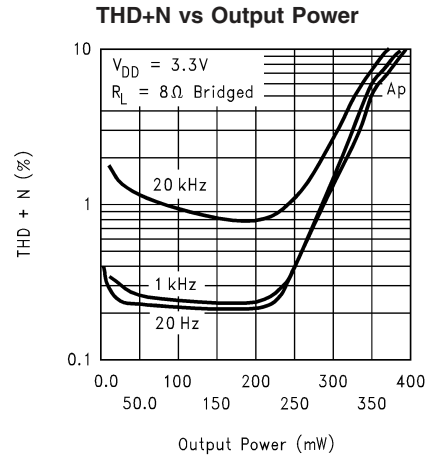

10104223

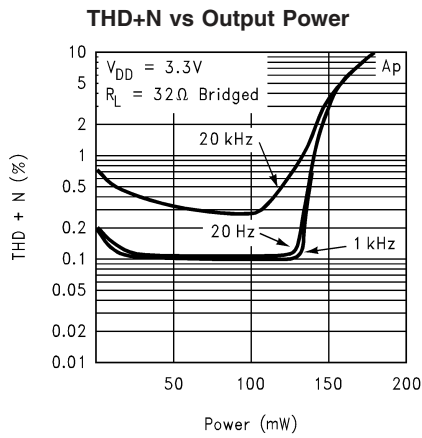

10104224

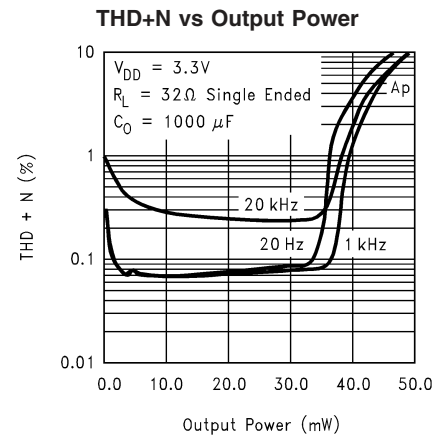

10104228

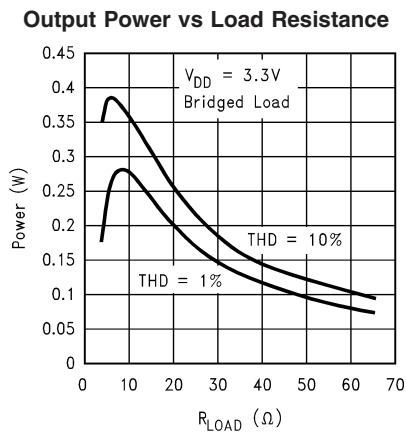

10104229

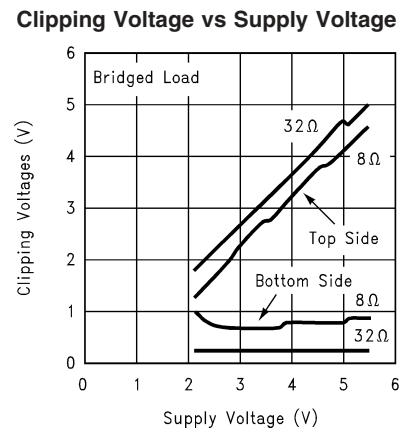

10104230

## Typical Performance Characteristics (Continued)

### Output Power vs Supply Voltage

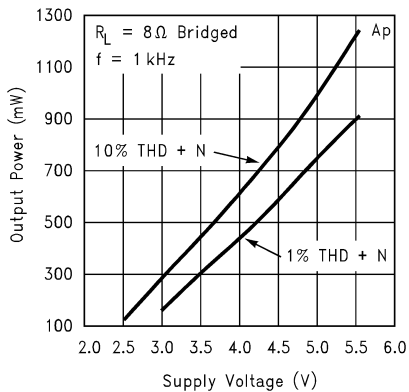

10104231

### Output Power vs Supply Voltage

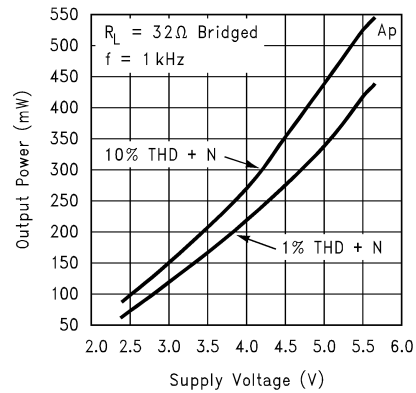

10104232

### Supply Current vs Supply Voltage

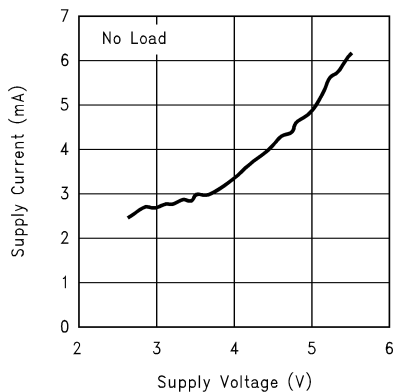

10104233

## Application Information

### BRIDGE CONFIGURATION EXPLANATION

As shown in *Figure 1*, the LM4875 consists of two operational amplifiers internally. An external DC voltage sets the closed-loop gain of the first amplifier, whereas two internal 20k $\Omega$  resistors set the second amplifier's gain at -1. The LM4875 can be used to drive a speaker connected between the two amplifier outputs or a monaural headphone connected between  $V_{O1}$  and GND.

*Figure 1* shows that the output of Amp1 serves as the input to Amp2. This results in both amplifiers producing signals that are identical in magnitude, but 180° out of phase.

Taking advantage of this phase difference, a load placed between  $V_{O1}$  and  $V_{O2}$  is driven differentially (commonly referred to as "bridge mode"). This mode is different from single-ended driven loads that are connected between a single amplifier's output and ground.

Bridge mode has a distinct advantage over the single-ended configuration: its differential drive to the load doubles the output swing for a specified supply voltage. This results in four times the output power when compared to a single-ended amplifier under the same conditions. This increase in attainable output assumes that the amplifier is not current limited or the output signal is not clipped. To ensure mini-

mum output signal clipping when choosing an amplifier's closed-loop gain, refer to the **Audio Power Amplifier Design** section.

Another advantage of the differential bridge output is no net DC voltage across load. This results from biasing  $V_{O1}$  and  $V_{O2}$  at half-supply. This eliminates the coupling capacitor that single supply, single-ended amplifiers require. Eliminating an output coupling capacitor in a single-ended configuration forces a single supply amplifier's half-supply bias voltage across the load. The current flow created by the half-supply bias voltage increases internal IC power dissipation and may permanently damage loads such as speakers.

### POWER DISSIPATION

Power dissipation is a major concern when designing a successful bridged or single-ended amplifier. Equation (1) states the maximum power dissipation point for a single-ended amplifier operating at a given supply voltage and driving a specified output load.

$$P_{DMAX} = (V_{DD})^2 / (2\pi^2 R_L) \quad \text{Single-Ended} \quad (1)$$

However, a direct consequence of the increased power delivered to the load by a bridge amplifier is an increase in internal power dissipation point for a bridge amplifier operating at the same given conditions.

$$P_{DMAX} = 4 * (V_{DD})^2 / (2\pi^2 R_L) \quad \text{Bridge Mode} \quad (2)$$

The LM4875 has two operational amplifiers in one package and the maximum internal power dissipation is 4 times that

## Application Information (Continued)

of a single-ended amplifier. However, even with this substantial increase in power dissipation, the LM4875 does not require heatsinking. From Equation (2), assuming a 5V power supply and an 8Ω load, the maximum power dissipation point is 633 mW. The maximum power dissipation point obtained from Equation (2) must not be greater than the power dissipation that results from Equation (3):

$$P_{DMAX} = (T_{JMAX} - T_A) / \theta_{JA} \quad (3)$$

For the SO package,  $\theta_{JA} = 150^\circ\text{C/W}$ . The MSOP package has a  $190^\circ\text{C/W}$   $\theta_{JA}$ .  $T_{JMAX} = 150^\circ\text{C}$  for the LM4875. For a given ambient temperature  $T_A$ , Equation (3) can be used to find the maximum internal power dissipation supported by the IC packaging. If the result of Equation (2) is greater than that of Equation (3), then either decrease the supply voltage, increase the load impedance, or reduce the ambient temperature. For a typical application using the SO packaged LM4875, a 5V power supply, and an 8Ω load, the maximum ambient temperature that does not violate the maximum junction temperature is approximately  $55^\circ\text{C}$ . The maximum ambient temperature for the MSOP package with the same conditions is approximately  $30^\circ\text{C}$ . These results further assume that a device is a surface mount part operating around the maximum power dissipation point. Since internal power dissipation is a function of output power, higher ambient temperatures are allowed as output power decreases. Refer to the **Typical Performance Characteristics** curves for power dissipation information at lower output power levels.

### POWER SUPPLY BYPASSING

As with any power amplifier, proper supply bypassing is critical for low noise performance and high power supply rejection. The capacitors connected to the bypass and power supply pins should be placed as close to the LM4875 as possible. The capacitor connected between the bypass pin and ground improves the internal bias voltage's stability, producing improved PSRR. The improvements to PSRR increase as the bypass pin capacitor value increases. Typical applications employ a 5V regulator with 10μF and a 0.1μF filter capacitors that aid in supply stability. Their presence, however does not eliminate the need for bypassing the supply nodes of the LM4875. The selection of bypass capacitor values, especially  $C_B$ , depends on desired PSRR requirements, click and pop performance (as explained in the section, **Proper Selection of External Components**), system cost, and size constraints.

### DC VOLTAGE VOLUME CONTROL

The LM4875's internal volume control is controlled by the DC voltage applied its DC Vol/SD pin (pin 4). The volume control's input range is from GND to  $V_{DD}$ . A graph showing a typical volume response versus input control voltage is shown in the **Typical Performance Characteristics** section. The DC Vol/SD pin also functions as the control pin for the LM4875's micropower shutdown feature. See the **Mute and Shutdown Function** section for more information.

Like all volume controls, the Lm4875's internal volume control is set while listening to an amplified signal that is applied to an external speaker. The actual voltage applied to the DC Vol/SD pin is a result of the volume a listener desires. As such, the volume control is designed for use in a feedback system that includes human ears and preferences. This feedback system operates quite well without the need for accurate gain. The user simply sets the volume to the desired level as determined by their ear, without regard to the

actual DC voltage that produces the volume. Therefore, the accuracy of the volume control is not critical, as long as volume changes monotonically and step size is small enough to reach a desired volume that is not too loud or too soft. Since gain accuracy is not critical, there may be a volume variation from part-to-part even with the same applied DC control voltage. The gain of a given LM4875 can be set with a fixed external voltage, but another LM4875 may require a different control voltage to achieve the same gain. *Figure 2* is a curve showing the volume variation of seven typical LM4875s as the voltage applied to the DC Vol/SD pin is varied. For gains between -20dB and +16dB, the typical part-to-part variation is typically  $\pm 1\text{dB}$  for a given control voltage.

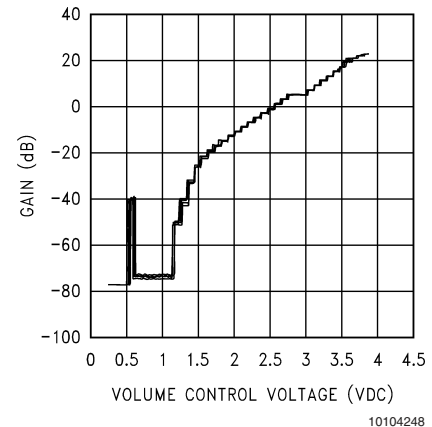

**FIGURE 2. Typical part-to-part gain variation as a function of DC-Vol control voltage**

### MUTE AND SHUTDOWN FUNCTION

The LM4875's mute and shutdown functions are controlled through the DC Vol/SD pin. Mute is activated by applying a voltage in the range of 500mV to 1V. A typical attenuation of 75dB is achieved while mute is active. The LM4875's micropower shutdown mode turns off the amplifier's bias circuitry. The micropower shutdown mode is activated by applying less than 300mV<sub>DC</sub> to the DC Vol/SD pin. When shutdown is active, they supply current is reduced to 0.7μA (typ). A degree of uncertainty exists when the voltage applied to the DC Vol/SD pin is in the range of 300mV to 500mV. The LM4875 can be in mute, still fully powered, or in micropower shutdown and fully muted. In mute mode, the LM4875 draws the typical quiescent supply current. The DC Vol/SD pin should be tied to GND for best shutdown mode performance. As the DC Vol/SD is increased above 0.5V the amplifier will follow the attenuation curve in **Typical Performance Characteristics**.

### HP-Sense FUNCTION

Applying a voltage between 4V and  $V_{CC}$  to the LM4875's HP-Sense headphone control pin turns off Amp2 and mutes a bridged-connected load. Quiescent current consumption is reduced when the IC is in this single-ended mode.

*Figure 3* shows the implementation of the LM4875's headphone control function. With no headphones connected to the headphone jack, the R1-R2 voltage divider sets the voltage applied to the HP-Sense pin (pin 3) at approximately 50mV. This 50mV enables the LM4875 and places it in bridged mode operation.



## Application Information (Continued)

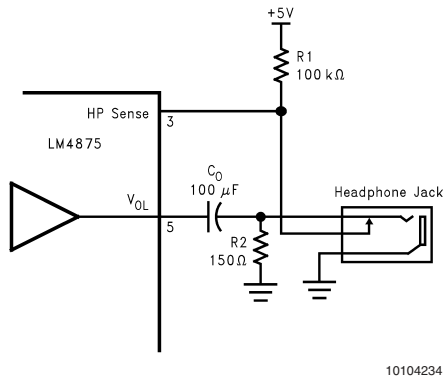

FIGURE 3. Headphone Circuit

While the LM4875 operates in bridged mode, the DC potential across the load is essentially 0V. Since the HP-Sense threshold is set at 4V, even in an ideal situation, the output swing cannot cause a false single-ended trigger. Connecting headphones to the headphone jack disconnects the headphone jack contact pin from  $V_{O1}$  and allows R1 to pull the HP Sense pin up to  $V_{CC}$ . This enables the headphone function, turns off Amp2, and mutes the bridged speaker. The amplifier then drives the headphones, whose impedance is in parallel with resistor R2. Resistor R2 has negligible effect on output drive capability since the typical impedance of headphones is 32Ω. The output coupling capacitor blocks the amplifier's half supply DC voltage, protecting the headphones.

A microprocessor or a switch can replace the headphone jack contact pin. When a microprocessor or switch applies a voltage greater than 4V to the HP Sense pin, a bridge-connected speaker is muted and Amp1 drives the headphones.

### SELECTING EXTERNAL COMPONENTS

Optimizing the LM4875's performance requires properly selecting external components. Though the LM4875 operates well when using external components having wide tolerances, the best performance is achieved by optimizing component values.

#### Input Capacitor Value Selection

Amplification of the lowest audio frequencies requires high value input coupling capacitors. These high value capacitors can be expensive and may compromise space efficiency in portable designs. In many cases, however, the speakers used in portable systems, whether internal or external, have little ability to reproduce signals below 150Hz. In application 5 using speakers with this limited frequency response, a large input capacitor will offer little improvement in system performance.

Figure 1 shows that the nominal input impedance ( $R_{IN}$ ) is 10kΩ at maximum volume and 110kΩ at minimum volume. Together, the input capacitor,  $C_i$ , and  $R_{IN}$ , produce a -3dB high pass filter cutoff frequency that is found using Equation (4).

$$f_{-3dB} = \frac{1}{2\pi R_{IN} C_i} \quad (4)$$

As the volume changes from minimum to maximum,  $R_{IN}$  decrease from 110kΩ to 10kΩ. Equation (4) reveals that the -3dB frequency will increase as the volume increases. The nominal value of  $C_i$  for lowest desired frequency response should be calculated with  $R_{IN} = 10k\Omega$ . As an example when using a speaker with a low frequency limit of 150Hz,  $C_i$ , using Equation (4) is 0.1μF. The 0.22μF  $C_i$  shown in Figure 1 is optimized for a speaker whose response extends down to 75Hz.

#### Bypass Capacitor Value Selection

Besides minimizing the input capacitor size, careful consideration should be paid to value of the bypass capacitor  $C_B$ . Since  $C_B$  determines how fast the LM4875 turns on, its value is the most critical when minimizing turn-on pops. The slower the LM4875's outputs ramp to their quiescent DC voltage (nominally  $V_{DD}/2$ ), the smaller the turn-on pop. Choosing  $C_B$  equal to 1.0μF, along with a small value of  $C_i$  (in the range of 0.1μF to 0.39μF), produces a clickless and popless shutdown function. Choosing  $C_i$  as small as possible helps minimize clicks and pops.

#### CLICK AND POP CIRCUITRY

The LM4875 contains circuitry that minimizes turn-on and shutdown transients or "clicks and pops". For this discussion, turn-on refers to either applying the power supply voltage or when the shutdown mode is deactivated. While the power supply is ramping to its final value, the LM4875's internal amplifiers are configured as unity gain buffers. An internal current source changes the voltage of the bypass pin in a controlled, linear manner. Ideally, the input and outputs track the voltage applied to the bypass pin. The gain of the internal amplifiers remains unity until the voltage on the bypass pin reaches  $1/2 V_{DD}$ . As soon as the voltage on the bypass pin is stable, the device becomes fully operational and the gain is set by the external voltage applied to the DC  $V_{OL}/SD$  pin.

Although the bypass pin current cannot be modified, changing the size of  $C_B$  alters the device's turn-on time and the magnitude of "clicks and pops". Increasing the value of  $C_B$  reduces the magnitude of turn-on pops. However, this presents a tradeoff: as the size of  $C_B$  increases, the turn-on time increases. There is a linear relationship between the size of  $C_B$  and the turn-on time. Shown below are some typical turn-on times for various values of  $C_B$ :

$C_B$	$T_{ON}$
0.01μF	3ms
0.1μF	30ms
0.22μF	65ms
0.47μF	135ms
1.0μF	280ms

In order eliminate "clicks and pops", all capacitors must be discharged before turn-on. Rapidly switching  $V_{DD}$  may not allow the capacitors to fully discharge, which may cause "clicks and pops". In a single-ended configuration, the output coupling capacitor,  $C_{OUT}$ , is of particular concern. This capacitor discharges through an internal 20kΩ resistor. Depending on the size of  $C_{OUT}$ , the time constant can be relatively large. To reduce transients in single-ended mode,

## Application Information (Continued)

an external  $1k\Omega$  -  $5k\Omega$  resistor can be placed in parallel with the internal  $20k\Omega$  resistor. The tradeoff for using this resistor is increased quiescent current.

### RECOMMENDED PRINTED CIRCUIT BOARD LAYOUT

Figure 4 through Figure 6 show the recommended two-layer PC board layout that is optimized for the SO-8 packaged LM4875 and associated external components. Figure 7 through Figure 9 show the recommended two-layer PC board layout for the MSOP packaged LM4875. Both layouts are designed for use with an external 5V supply,  $8\Omega$  speakers, and  $8\Omega$  -  $32\Omega$  headphones. The schematic for both recommended PC board layouts is Figure 1.

Both circuit boards are easy to use. Apply a 5V supply voltage and ground to the board's  $V_{DD}$  and GND pads, respectively. Connect a speaker with an  $8\Omega$  minimum impedance between the board's -OUT and +OUT pads. For headphone use, the layout has provisions for a headphone jack, J1. When a jack is connected as shown, inserting a headphone plug automatically switches off the external speaker.

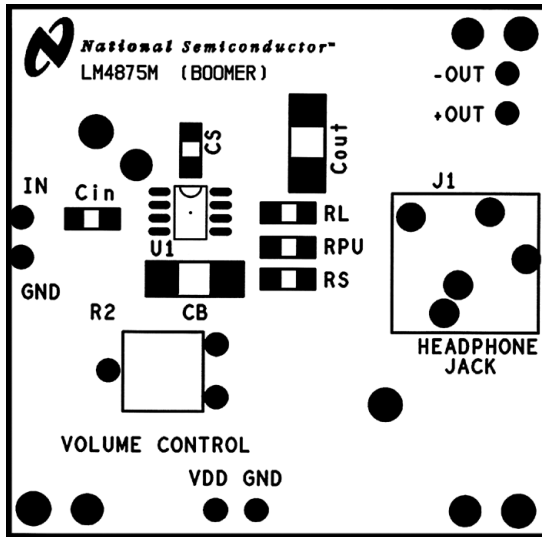

10104238

FIGURE 4. Recommended SO PC board layout: component side silkscreen

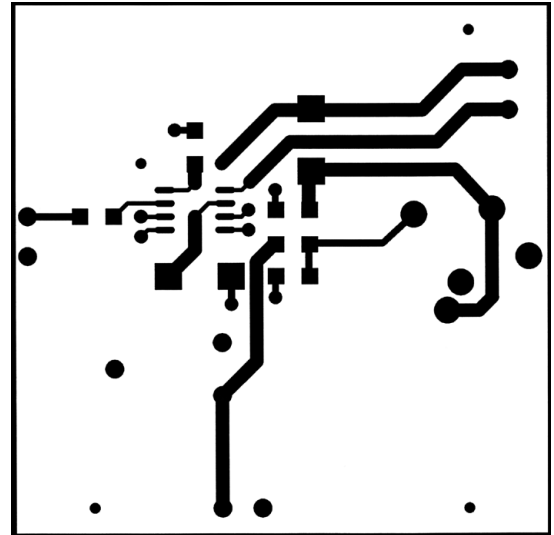

10104239

FIGURE 5. Recommended SO PC board layout: component side layout

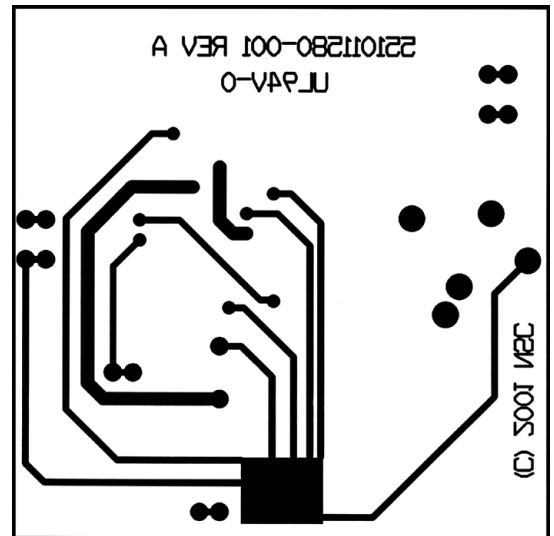

10104240

FIGURE 6. Recommended SO PC board layout: bottom side layout

Application Information (Continued)

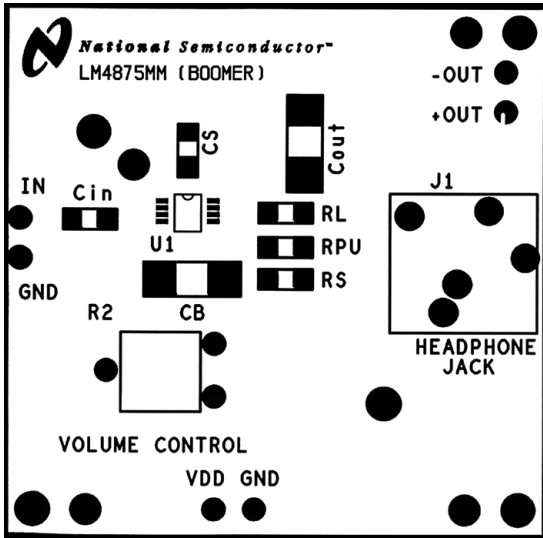

10104241

FIGURE 7. Recommended MSOP PC board layout: component side silkscreen

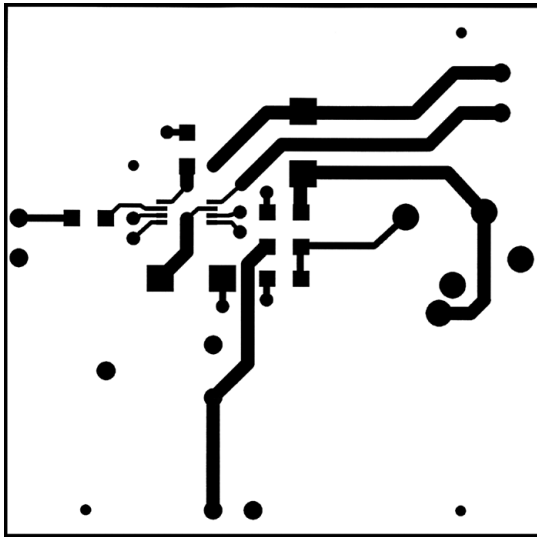

10104242

FIGURE 8. Recommended MSOP PC board layout: component side layout

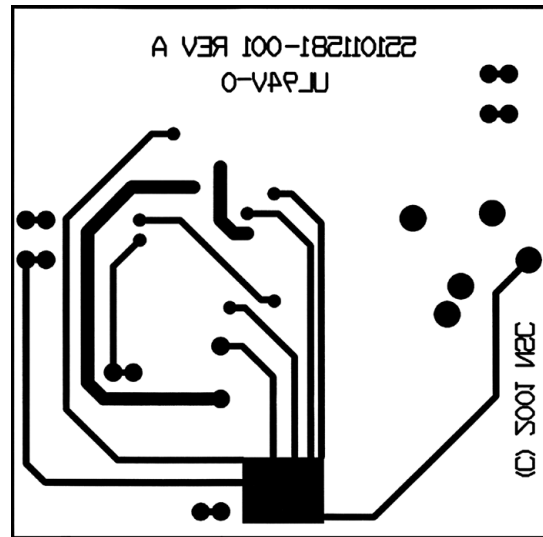

10104245

FIGURE 9. Recommended MSOP PC board layout: bottom side layout

**Physical Dimensions** inches (millimeters) unless otherwise noted

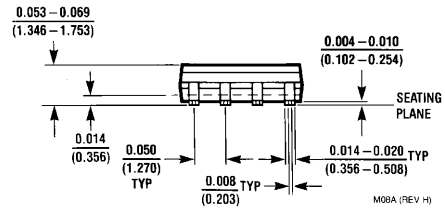
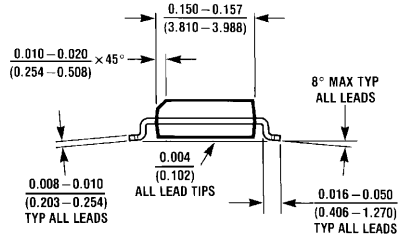
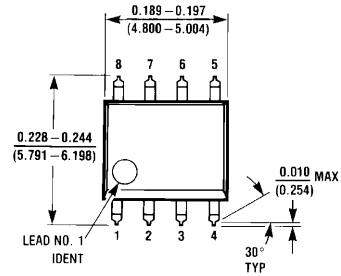

Order Number LM4875M  
NS Package Number M08A

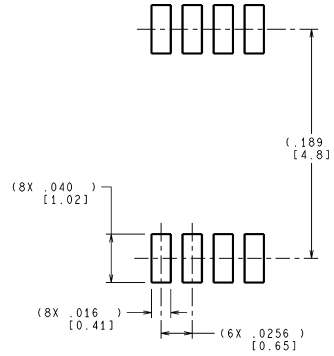
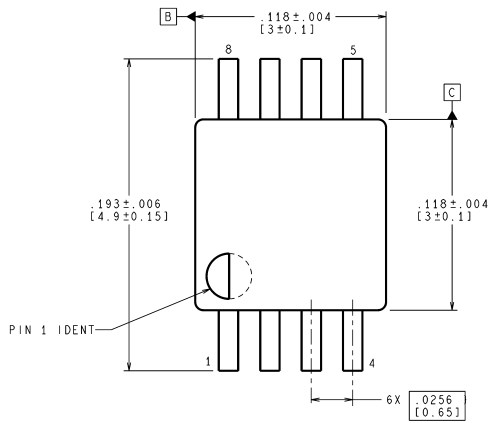

LAND PATTERN RECOMMENDATION

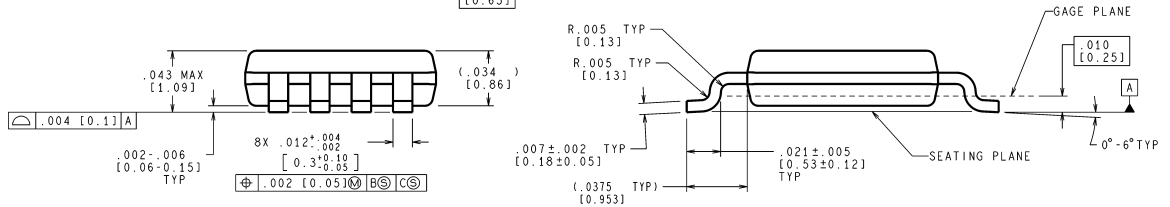

CONTROLLING DIMENSION IS INCH  
VALUES IN [ ] ARE MILLIMETERS

MUA08A (Rev E)

**8-Lead (0.118" Wide) Molded Mini Small Outline Package**  
Order Number LM4875MM  
NS Package Number MUA08A

## Notes

National does not assume any responsibility for use of any circuitry described, no circuit patent licenses are implied and National reserves the right at any time without notice to change said circuitry and specifications.

For the most current product information visit us at [www.national.com](http://www.national.com).

### LIFE SUPPORT POLICY

NATIONAL'S PRODUCTS ARE NOT AUTHORIZED FOR USE AS CRITICAL COMPONENTS IN LIFE SUPPORT DEVICES OR SYSTEMS WITHOUT THE EXPRESS WRITTEN APPROVAL OF THE PRESIDENT AND GENERAL COUNSEL OF NATIONAL SEMICONDUCTOR CORPORATION. As used herein:

1. Life support devices or systems are devices or systems which, (a) are intended for surgical implant into the body, or (b) support or sustain life, and whose failure to perform when properly used in accordance with instructions for use provided in the labeling, can be reasonably expected to result in a significant injury to the user.
2. A critical component is any component of a life support device or system whose failure to perform can be reasonably expected to cause the failure of the life support device or system, or to affect its safety or effectiveness.

### BANNED SUBSTANCE COMPLIANCE

National Semiconductor certifies that the products and packing materials meet the provisions of the Customer Products Stewardship Specification (CSP-9-111C2) and the Banned Substances and Materials of Interest Specification (CSP-9-111S2) and contain no "Banned Substances" as defined in CSP-9-111S2.



**National Semiconductor**  
**Americas Customer**  
**Support Center**  
 Email: [new.feedback@nsc.com](mailto:new.feedback@nsc.com)  
 Tel: 1-800-272-9959

**National Semiconductor**  
**Europe Customer Support Center**  
 Fax: +49 (0) 180-530 85 86  
 Email: [europe.support@nsc.com](mailto:europe.support@nsc.com)  
 Deutsch Tel: +49 (0) 69 9508 6208  
 English Tel: +44 (0) 870 24 0 2171  
 Français Tel: +33 (0) 1 41 91 8790

**National Semiconductor**  
**Asia Pacific Customer**  
**Support Center**  
 Email: [ap.support@nsc.com](mailto:ap.support@nsc.com)

**National Semiconductor**  
**Japan Customer Support Center**  
 Fax: 81-3-5639-7507  
 Email: [jpn.feedback@nsc.com](mailto:jpn.feedback@nsc.com)  
 Tel: 81-3-5639-7560